

LOBERON

COMING HOME

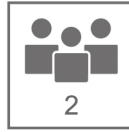

Ax1	Bx1	Cx1	Dx4	Ex4	Fx1
			$\phi 6$	$\phi 6 \times 40 \text{mm}$	$\phi 6$

1

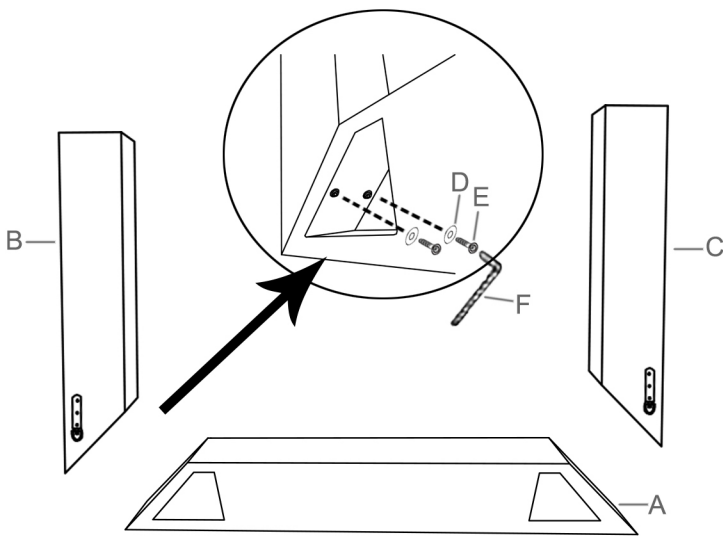

2

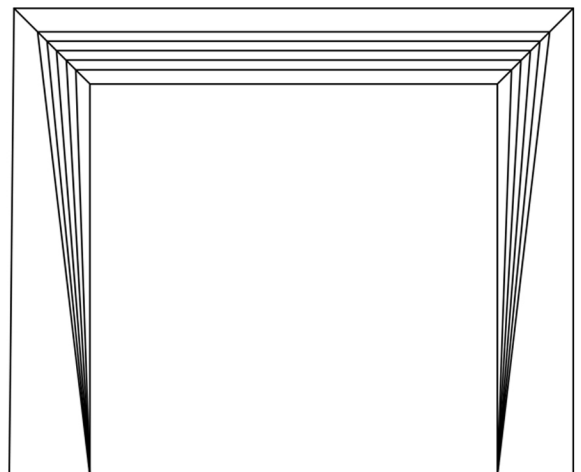

LOBERON

COMING HOME

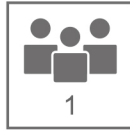

Ax2



Bx4

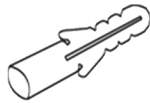

Cx4

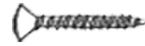

φ3.5x40mm

Dx2



1

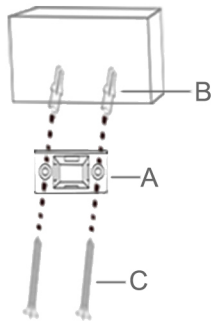

2

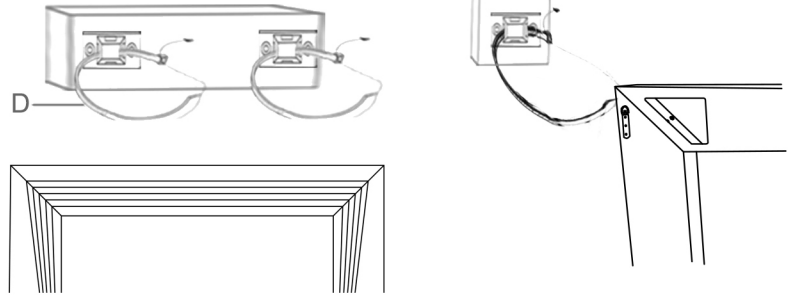

3

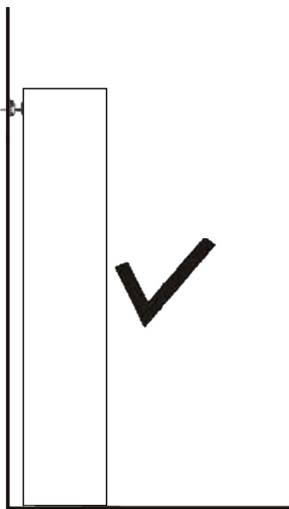

4

